

Revision Notes.			
R1 - CORRECTIONS TO DRAWING DIMENSIONS (AS PER P1360).			
APA: w.wu (17/09/2020)	Drawn: J.STEWART	Checked: S.GOVENDER	Approved: S.LAVER
			Date: 17/09/2020

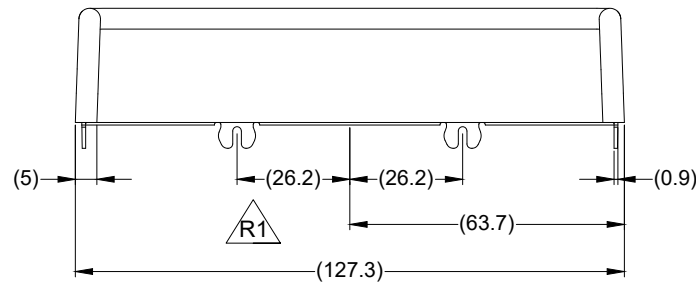
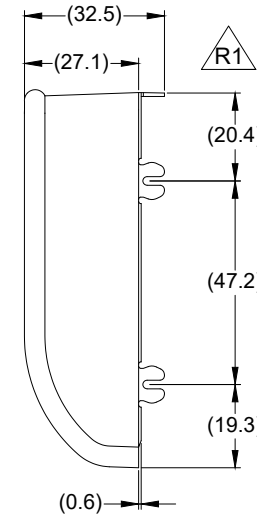
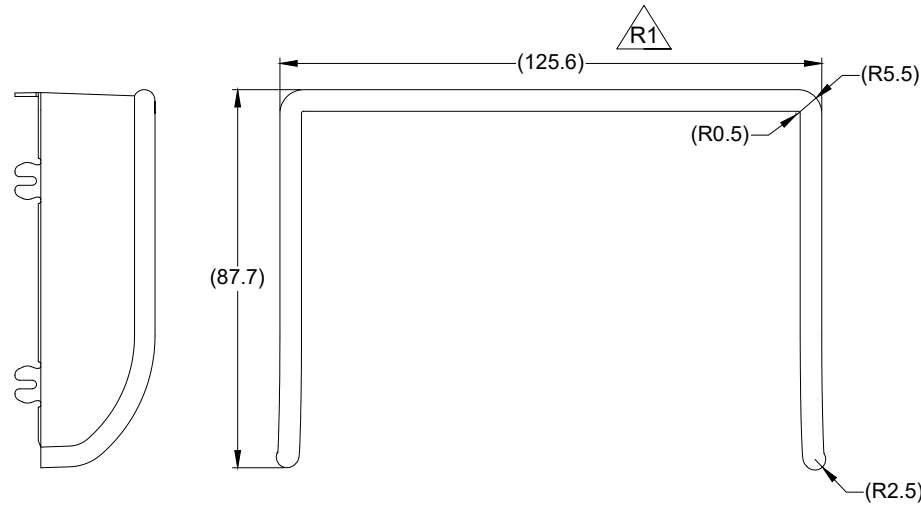
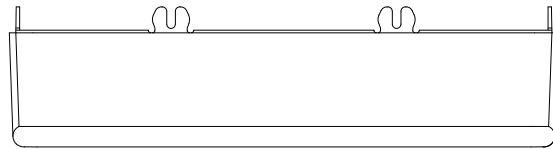
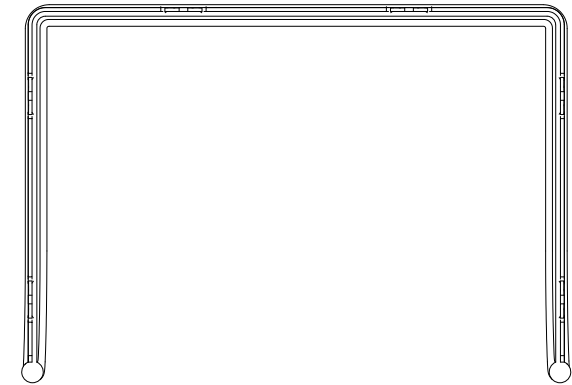
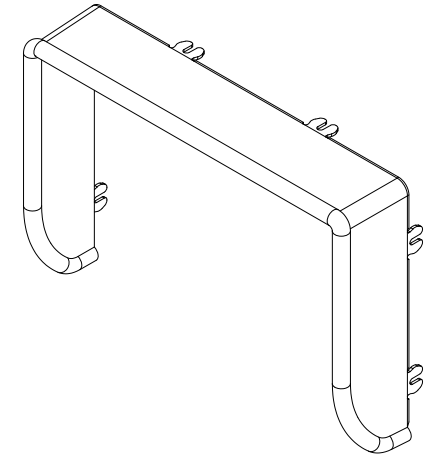

- NOTES:
1. FINISH: TEXTURED, MATT BLACK.
  2. MATERIAL: ABS-757.

PROPRIETARY NOTICE  
 THIS DESIGN AND TECHNICAL INFORMATION APPEARING ON THIS DRAWING IS THE PROPERTY OF BRIGADE ELECTRONICS, AND IS DISCLOSED IN CONFIDENCE. IT IS NOT TO BE COPIED, REPRODUCED, REVEALED TO OR EXPROPRIATED BY OTHERS, EITHER IN WHOLE OR IN PART WITHOUT THE EXPRESS WRITTEN CONSENT OF BRIGADE ELECTRONICS.

**BRIGADE**<sup>®</sup>  
 www.brigade-electronics.com

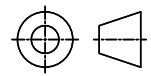
Assembly Pl Approval WENFENG QIN (03/04/14)	Approved by B.JOHN	Checked by R.BATES	Drawn by M.BUTLER
Angle of Projection 	Units mm	Scale N/A	Released 03/04/14
	Status RELEASED	Assembly Ref VBV-750M-SS	
	Part No 4366	BE-002716-01-13	